

ANA2

ANA3

FROM RESEARCH TO INDUSTRY

cea tech



ADEME



Agence De l'Environnement  
et de la Maitrise de l'Énergie



Laboratoire des Signaux & Systèmes



## *A parametric study to support the modelling of space heating demand in view of developing a load shedding algorithm*

*Nadine Aoun<sup>a,b,c,\*</sup>, Roland Bavière<sup>b</sup>, Mathieu Vallée<sup>b</sup> and Guillaume Sandou<sup>a</sup>*

<sup>a</sup> L2S, CentraleSupélec, CNRS, Université Paris-Sud, Université Paris-Saclay, 91190 Gif-sur-Yvette

<sup>b</sup> CEA, LITEN, 17 rue des Martyrs, F-38054 Grenoble, France

<sup>c</sup> ADEME, 20 Avenue du Grésillé, 49000 Angers, France

3<sup>RD</sup> INTERNATIONAL CONFERENCE ON

SMART ENERGY SYSTEMS AND  
4<sup>TH</sup> GENERATION DISTRICT HEATING

COPENHAGEN, 12-13 SEPTEMBER 2017

**Slide 1**

---

**ANA2**      The French Environmental and Energy Management Agency - ADEME

AOUN Nadine ADEME, 9/5/2017

**ANA3**      The French Alternative Energies and Atomic Energy Commission - CEA

AOUN Nadine ADEME, 9/5/2017

# Advanced control of DHSs using heat demand flexibility

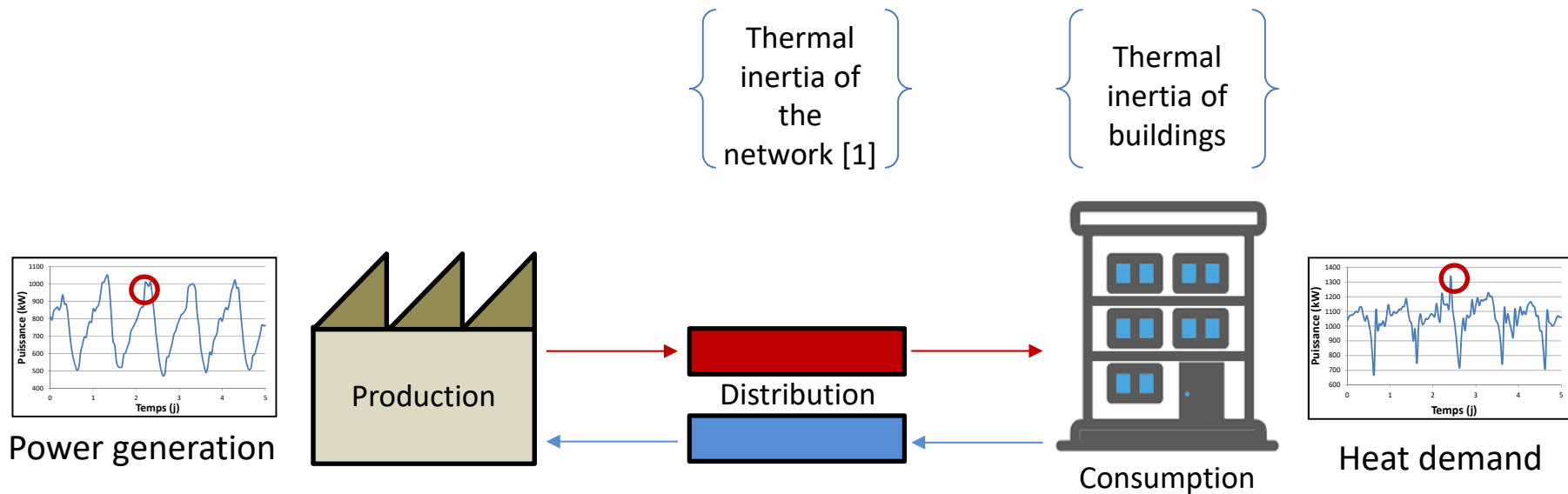

[1] L. Giraud – 2016, PhD Thesis “Dynamic modelling and advanced management of district heating systems”

# Identification of a suitable building model for model-based operational optimization of a DHS scale

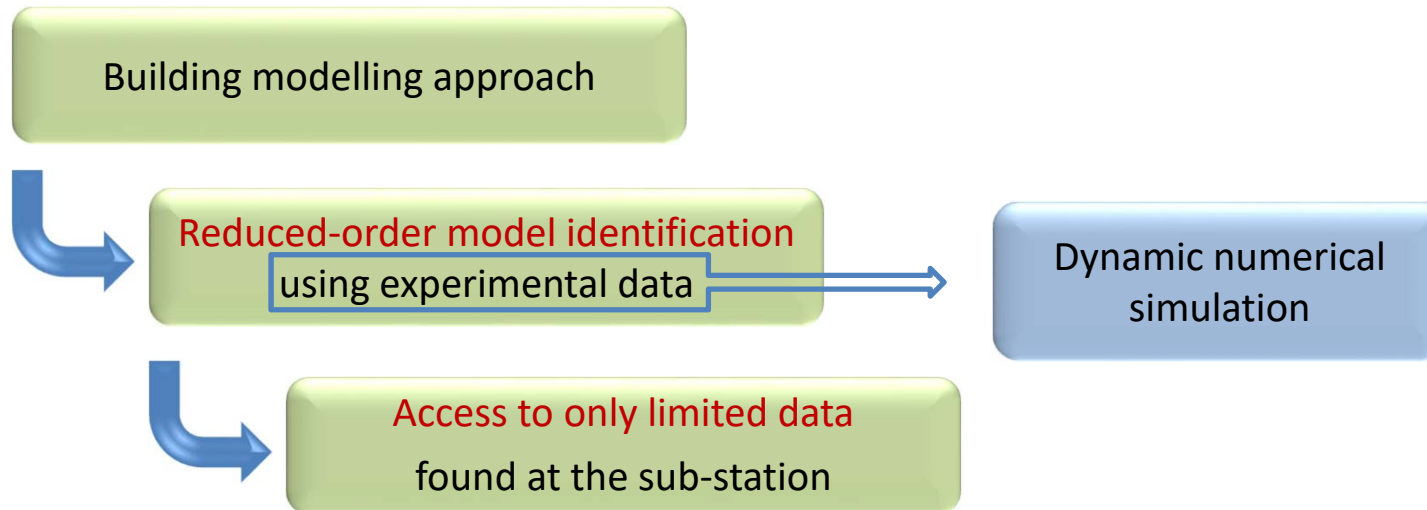

Which elements of the dynamic simulation model have a higher impact on the thermal inertia of the building

What structure should the identified reduced-order model have



# Influence of model's parameters on the thermal dynamics

## Introducing the dynamic simulation building model



Building simulation is performed in **Modelica** component-based language.  
The base component is **MixedAir** of the **Buildings Library** [2]

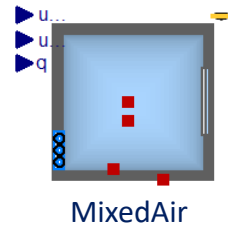

Accounts for:

- Heat conduction
- Longwave infrared and solar radiation
- Heat convection
- Radiative and convective heat flux delivered by an external heating system
- Radiative, convective and latent internal heat gain
- Heat transfer by fluid inlets and outlets



Case study: Le Sallambô, 8-storey apartment building served by the DHS of Grenoble operated by CCIAG\*

**Model validated using the ANSI/ASHRAE Standard envelope test**

\* CCIAG : Compagnie de Chauffage Intercommunale de l'Agglomération Grenobloise – DHS Operator of the city of Grenoble, second largest DHSs of France  
[2] M. Wetter – 2013, "Modeling of heat transfer in rooms in the Modelica Buildings Library"

# Influence of model's parameters on the thermal dynamics

## Introducing the dynamic simulation building model



Each floor is assumed to have a  $28.21 \times 10.85 \text{ m}^2$  surface area and is modelled using 4 MixedAir components

### Main assumptions:

- Aeraulic flows are not modelled
- Ventilation and infiltration are modelled as a direct heat flux injected to the air node
- Thermal bridges are taken into account by multiplying the heat conductivity of construction material by a calibrated factor
- Internal heat gains are not modelled yet

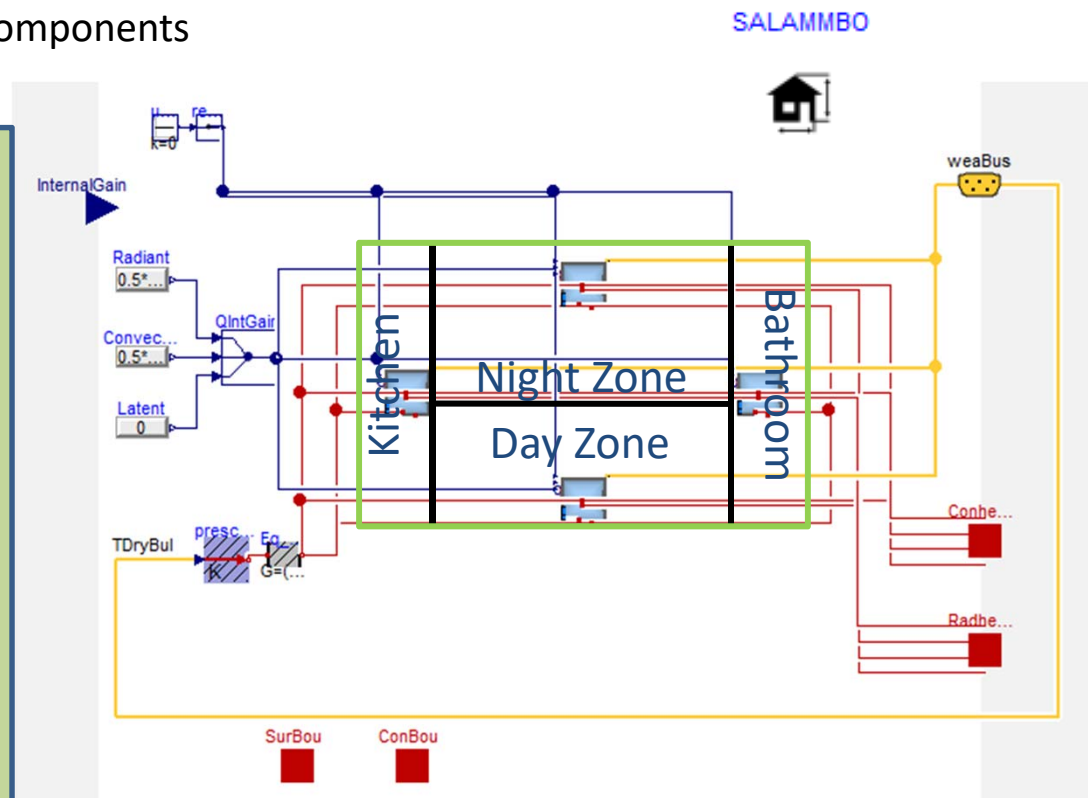

# Influence of model's parameters on the thermal dynamics

## Introducing the heating systems models



A- Ideal indoor air temperature control



AirTemperature(t) = SetPointTemperature

B- Explicit modelling of the sub-station, pipes, thermostatic radiator valves and radiators developed in the Modelica DistrictHeating Library \*[3]

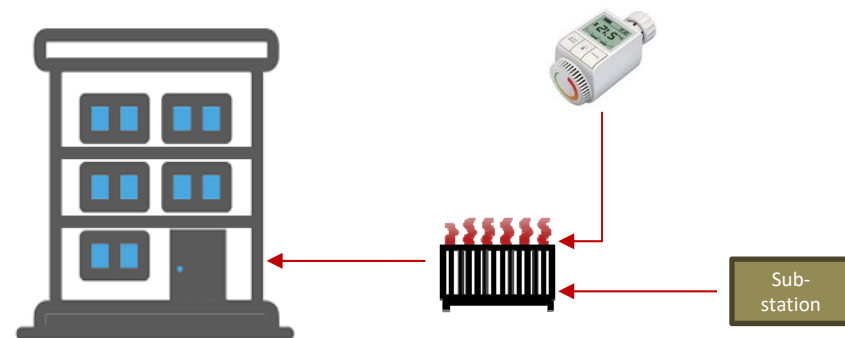

\*\* A Modelica library of DHS's components including pipes, sub-stations and regulation systems developed at CEA-INES  
[3] L. Giraud et al – 2015 "Presentation, validation and application of the DistrictHeating Modelica library"

# Influence of model's parameters on the thermal dynamics

Defining the **variable parameters** and setting the **simulations matrix**

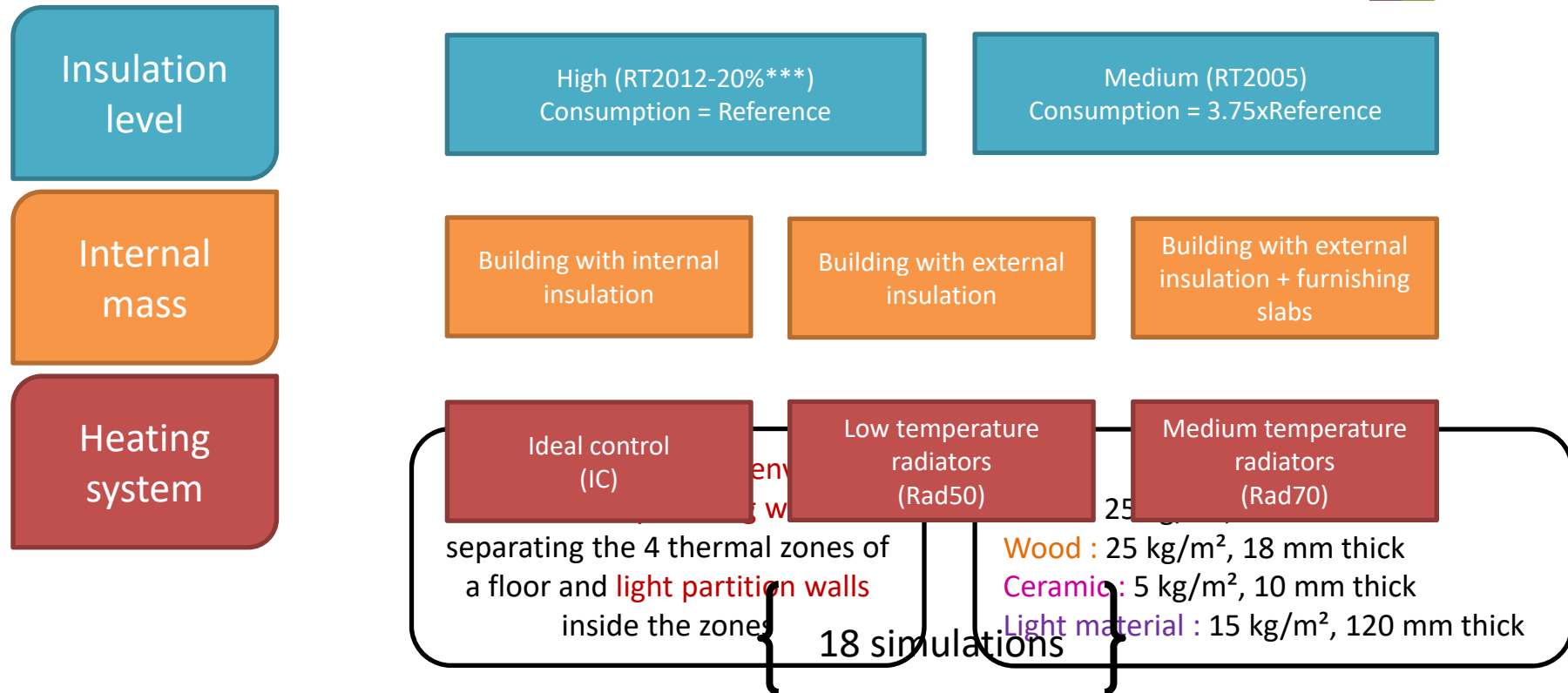

<sup>\*\*\*</sup> A building that satisfies the requirements of the latest French legislation issued in 2012, and consumes 20% less than the legislation's limits.

[4] H. Johra et al – 2017 – “Influence of internal thermal mass on the indoor thermal dynamics and integration of phase change materials in furniture for building energy storage: A review”



# Influence of model's parameters on the thermal dynamics

Describing the experimental protocol and the comparative quantity

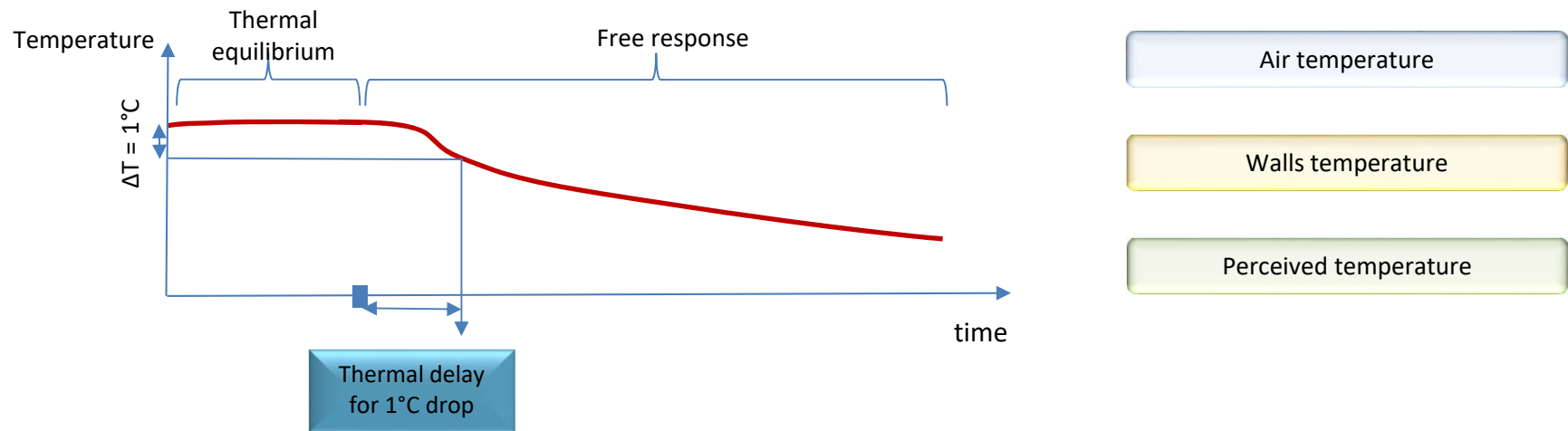
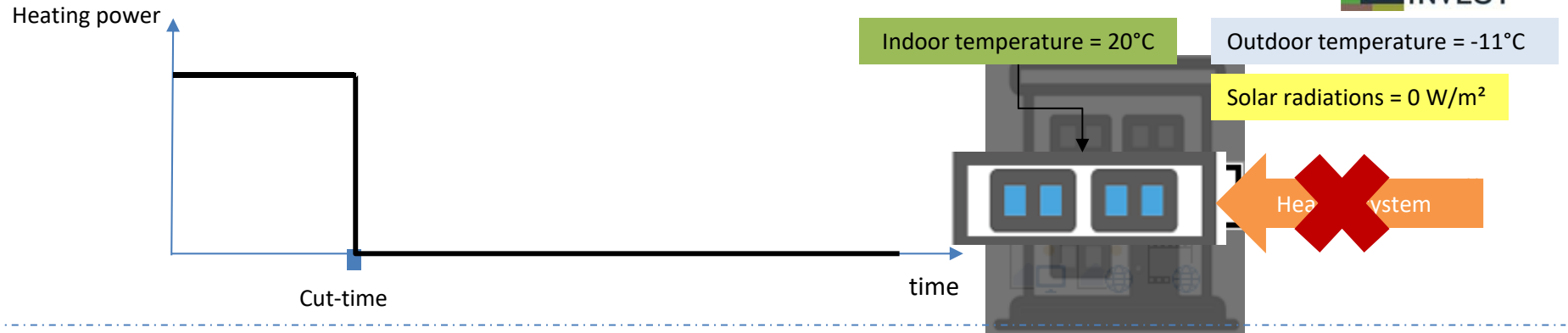

# Influence of model's parameters on the thermal dynamics

## Results and preliminary conclusions



Normalized temperature

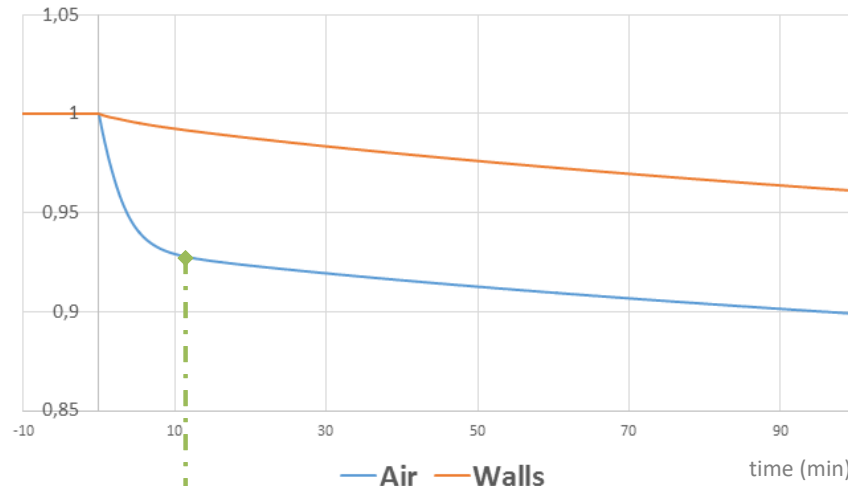

Heat flux % to total heating power at steady state

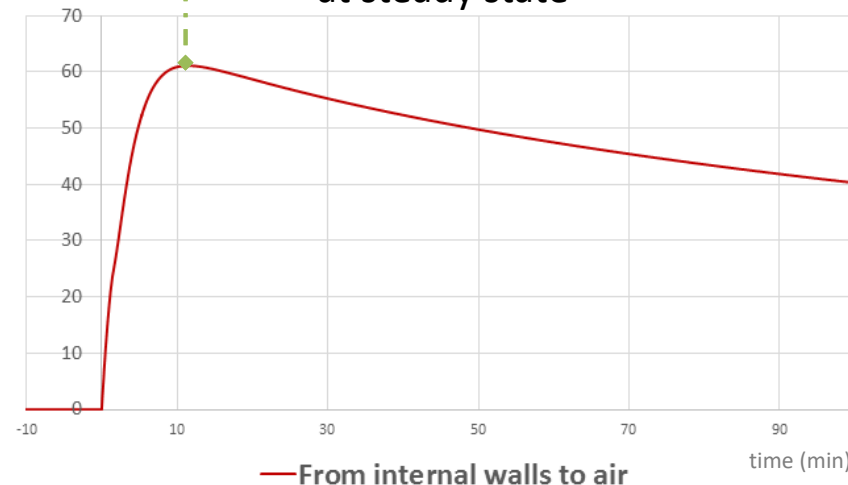

— From internal walls to air

Insulation level	RT2012 – 20% (Well insulated)
Internal mass	External insulation + Furnishing
Heating system	Ideal Control (IC)

ANA1

The graph shows **the average temperatures of the 4 zones of an intermediate floor weighted by their surface fractions** in a **normalized** form:

$$T_{norm}(t) = 1 - \frac{T_{set\ point} - T(t)}{T_{set\ point} - T_{outdoor}}$$

- $T_{set\ point} = 20^{\circ}C$
- $T_{outdoor} = -11^{\circ}C$
- time=0s → Heating power cut-time, start of the free response

- Air temperature curve is **steep at the beginning** of the drop.
- Air temperature curve **gets flatter** as soon as the heat flux given by the internal surfaces to the mixed air inside the zone reaches its peak.

**ANA1**

If we analyze few results, the first think we notice in all different cases is that convective and radiative temperatures have distinct dynamics. In this graph we have a case of direct air temperature control, we see the evolution from the beginning of the simulation (that is time = -50 min) through the instant at time = 0 when we cut the control signal, and the free response to the end of the simulation. The plot shows normalized temperatures so values range between 1 (initial temperature at the cut time) and 0 (the final temperature). Convective temperature is characterized by a steep drop in the few minutes following the cut time. It means the air loses its heat quickly as its temperature is greater than walls temperature. From the moment when the convective temperature equals the radiative temperature, its curve becomes flatter.

AOUN Nadine ADEME, 9/3/2017

# Influence of model's parameters on the thermal dynamics

## Results and preliminary conclusions



Normalized temperature

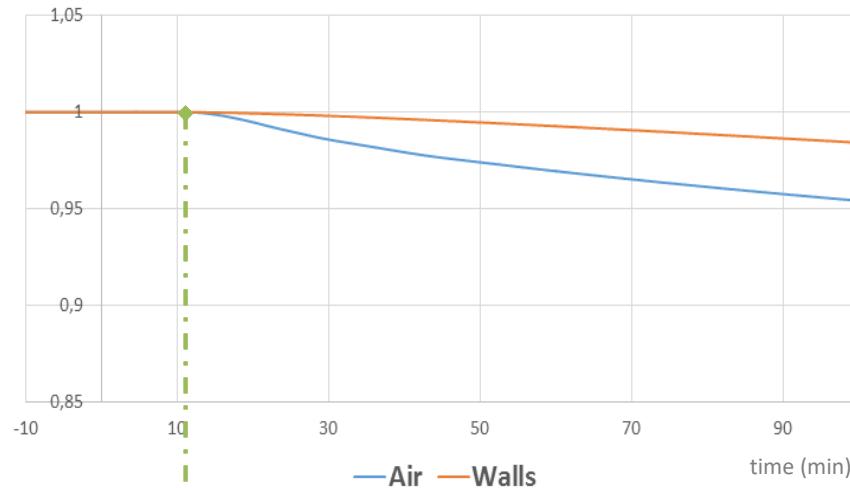

Heat flux % to total heating power at steady state

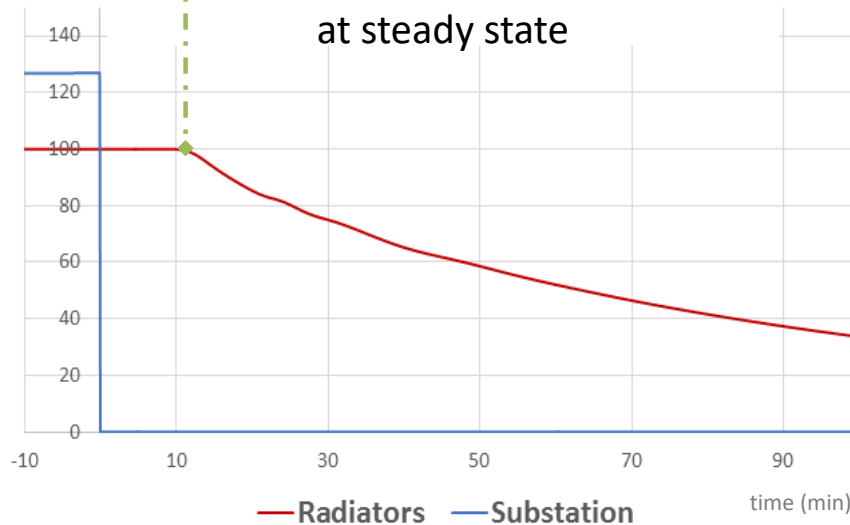

Insulation level	RT2012 – 20% (Well insulated)
Internal mass	External insulation + Furnishing
Heating system	Medium temperature radiators (Rad70)

- When the heating system is explicitly modelled, the **thermal delay is significantly increased** due to the **thermal inertia of water** in the heating circuit between the sub-station and the radiator

# Influence of model's parameters on the thermal dynamics

Results and preliminary conclusions



Insulation level

RT2012 – 20%

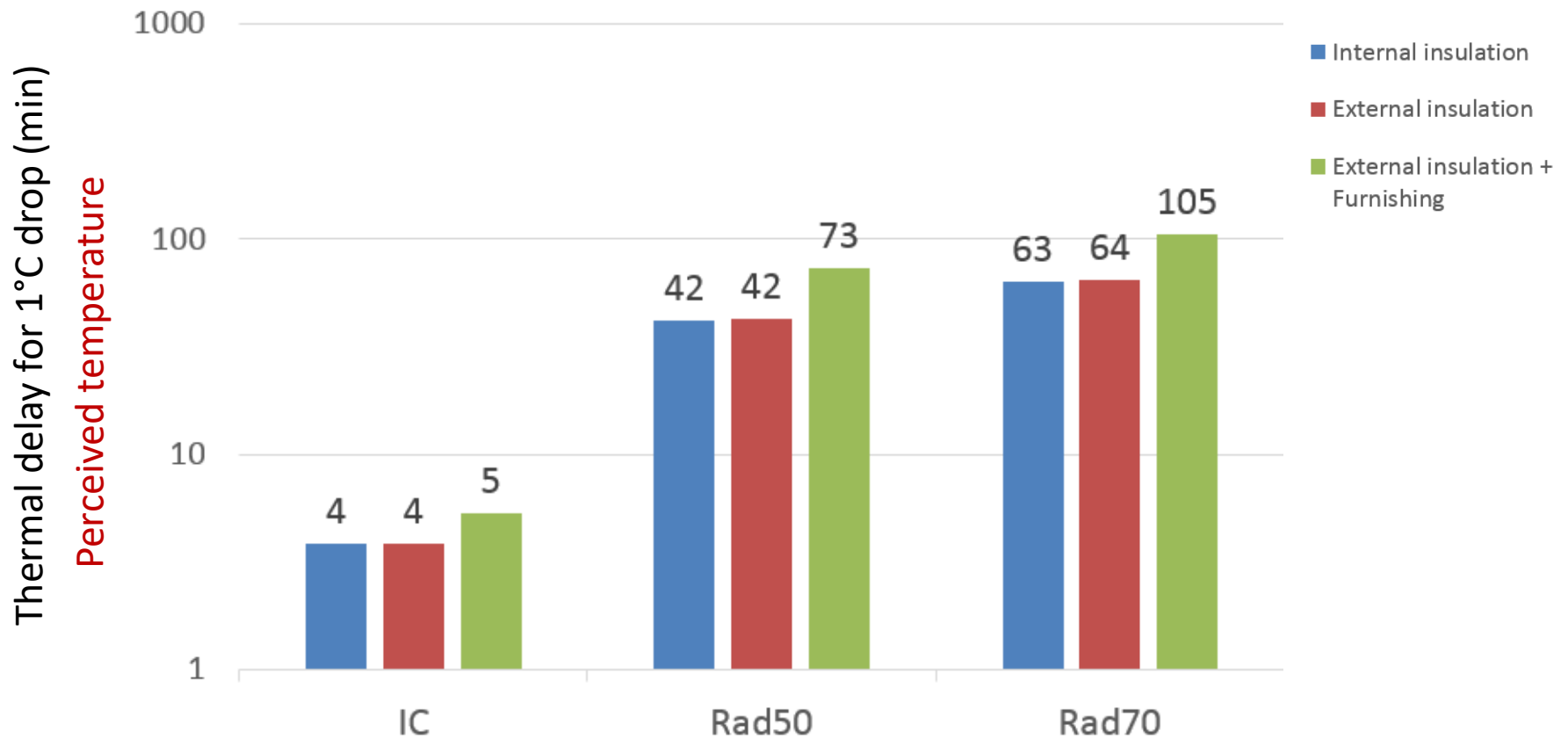

# Influence of model's parameters on the thermal dynamics

Results and preliminary conclusions



**4DH**

- Internal insulation
- External insulation
- External insulation + Furnishing

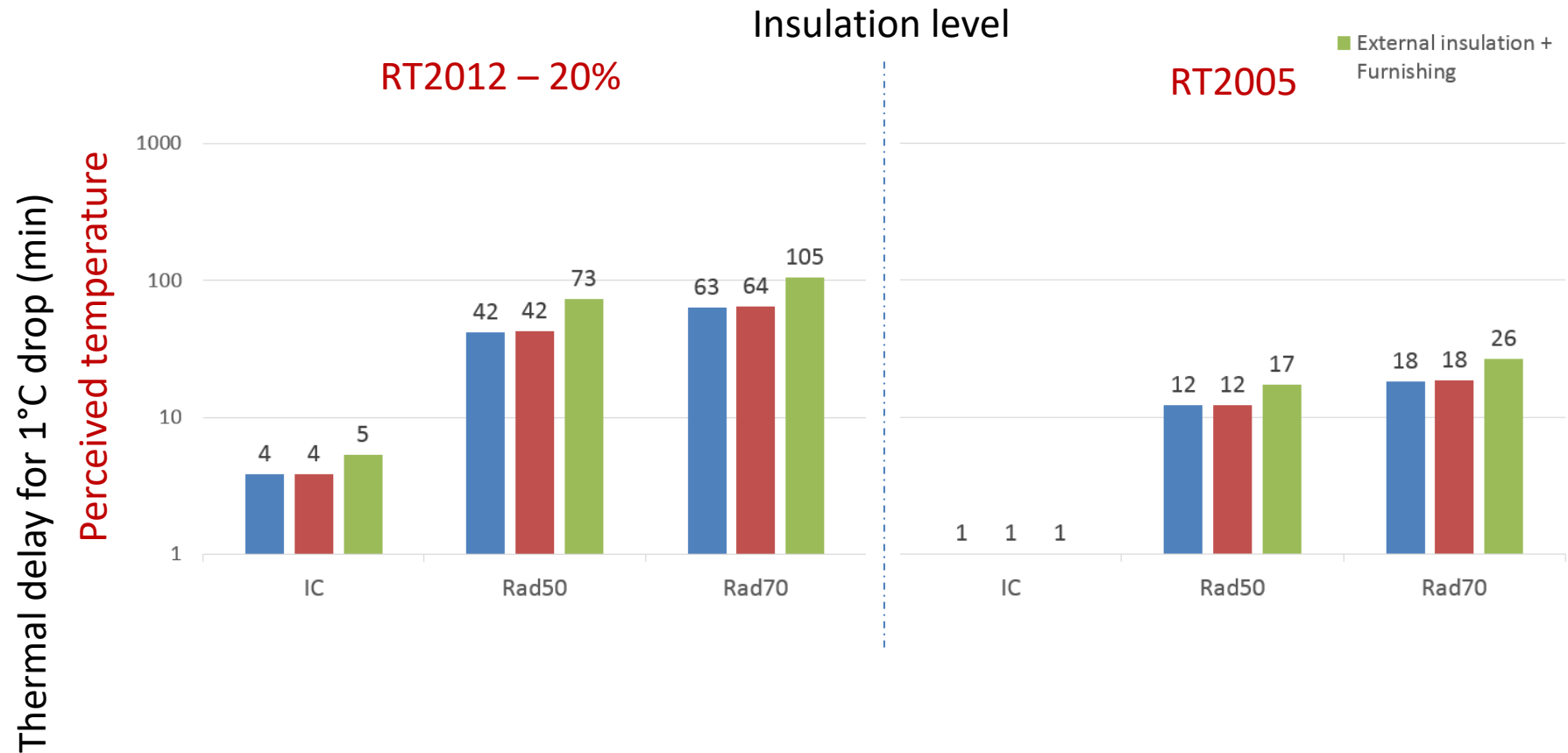

# Influence of model's parameters on the thermal dynamics

Results and preliminary conclusions



**4DH**

- Internal insulation
- External insulation
- External insulation + Furnishing

Insulation level

RT2012 – 20%

RT2005

Thermal delay for 1°C drop (min)

Perceived temperature

Walls temperature

Air temperature

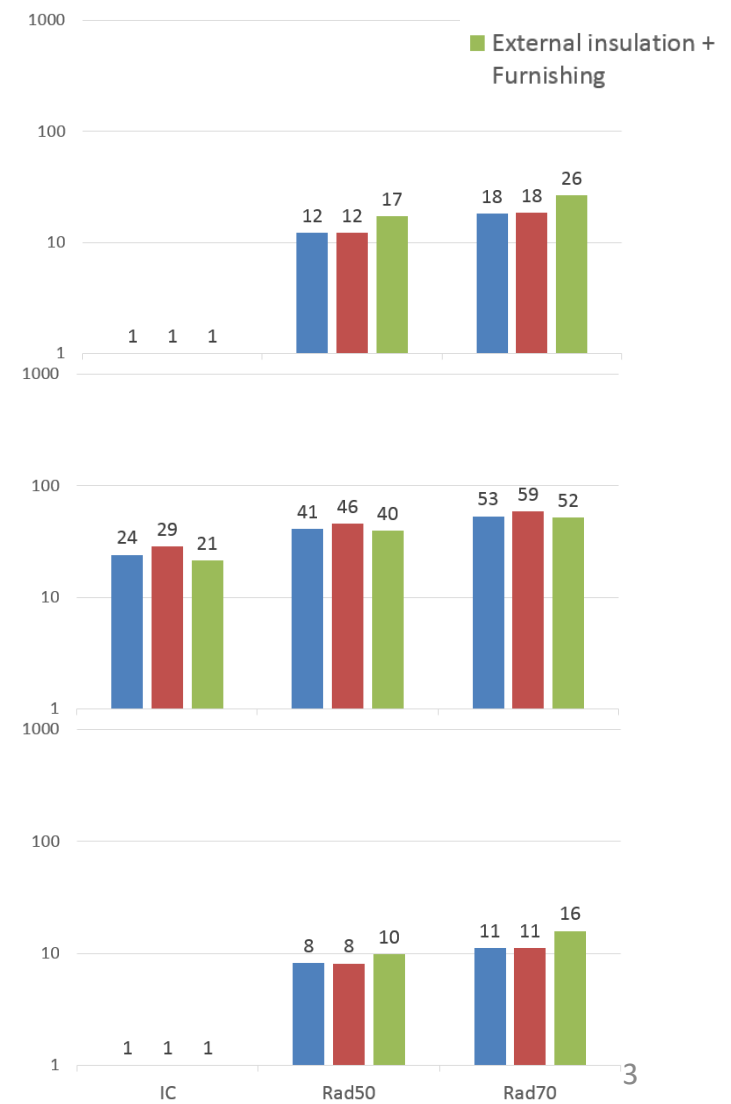
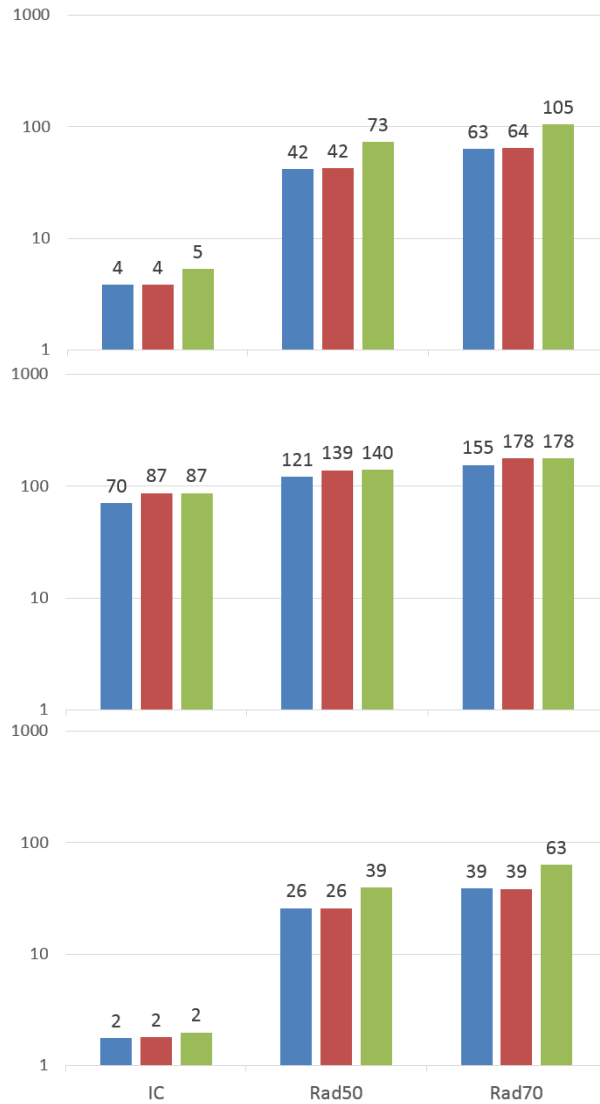

## Conclusions and upcoming steps



The study quantitatively proves the importance of:

- Distinguishing the air temperature from the walls temperature and considering an intermediate temperature for control.
- Explicit modelling of the heating system
- Including internal mass

Upcoming steps:

- Investigation of the case of **floor heating**.
- Classification of the set of existing buildings into several categories and proposition of a suitable reduced-order model structure for each category



FROM RESEARCH TO INDUSTRY  
**cea tech**



**ADEME**



Agence De l'Environnement  
et de la Maitrise de l'Énergie



Laboratoire des Signaux & Systèmes



3<sup>RD</sup> INTERNATIONAL CONFERENCE ON  
**SMART ENERGY SYSTEMS AND  
4<sup>TH</sup> GENERATION DISTRICT HEATING**

COPENHAGEN, 12-13 SEPTEMBER 2017

**Thank you**  
**nadine.aoun@cea.fr**

---

# Influence of model's parameters on the thermal dynamics

Results and preliminary conclusions



Theoretically

$$\text{Thermal delay} \propto \text{Time constant} \equiv \frac{\text{Thermal capacity}}{\text{Heat losses}}$$

Insulation level	8 different levels
Internal mass	External insulation + Furnishing
Heating system	Medium temperature radiators

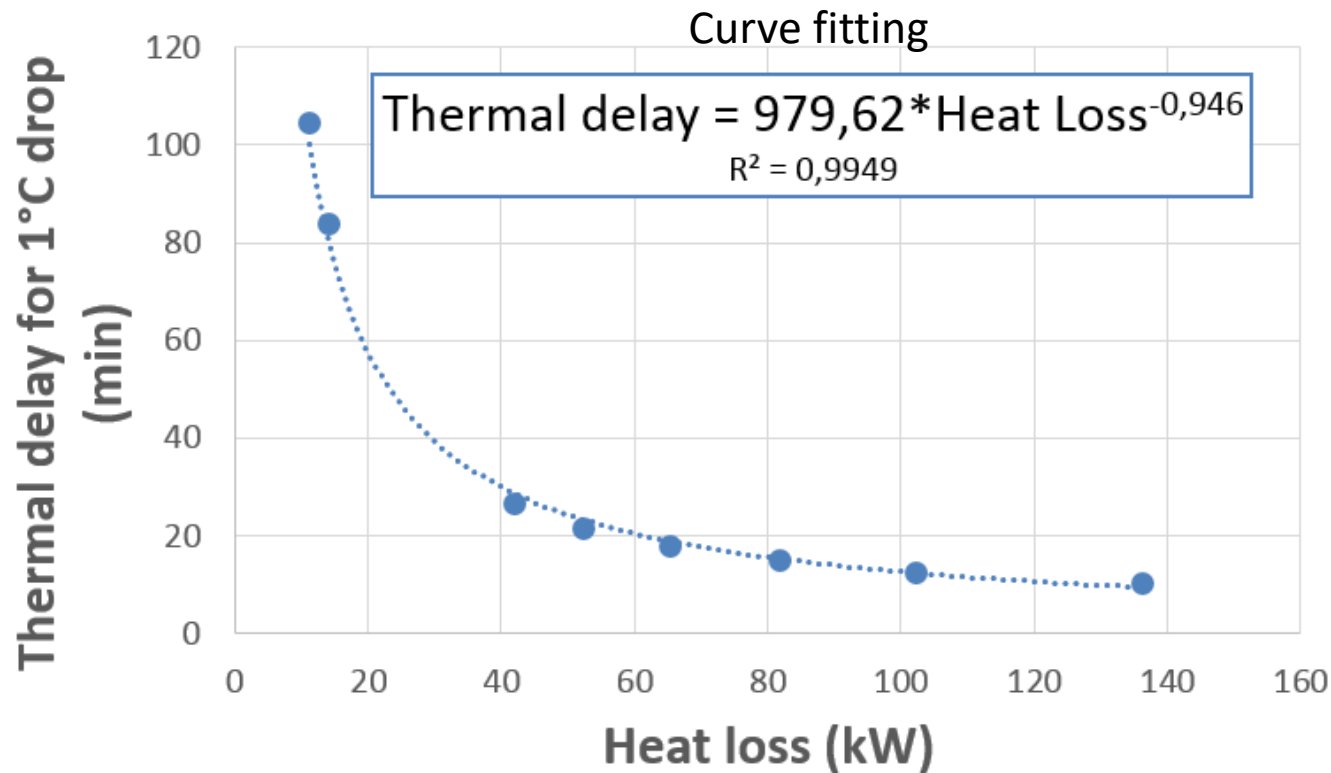

# Identification of a suitable building model for model-based operational optimization of a DHS scale

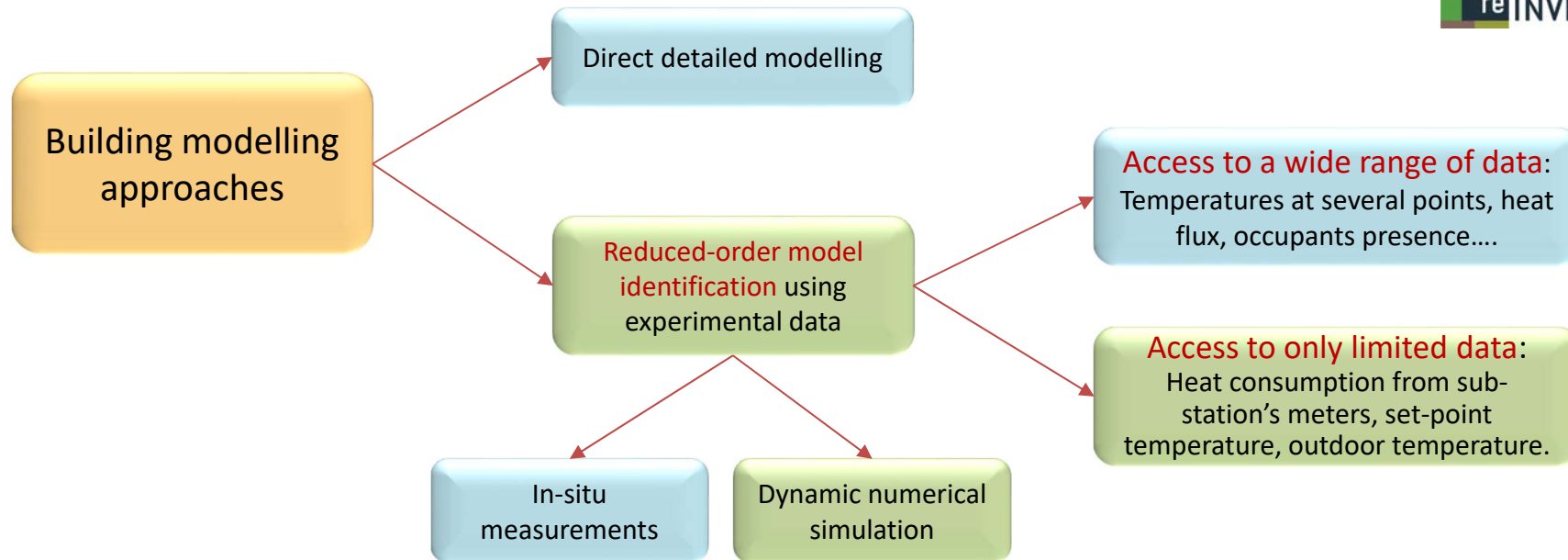

Which elements of the dynamic simulation model have a higher impact on the thermal inertia of the building  
 What structure should the identified reduced-order model have

